



Model Number

OBD1000-R101-2EP-IO-V31

Diffuse mode sensor
with 4-pin, M8 x 1 connector

Features

- Miniature design with versatile mounting options
- Extended temperature range
-40°C ... 60°C
- High degree of protection IP69K
- IO-link interface for service and process data

Product information

The R101 series miniature optical sensors are the first devices of their kind to offer an end-to-end solution in a small single standard design — from thru-beam sensor through to a distance measurement device. As a result of this design, the sensors are able to perform practically all standard automation tasks. The entire series enables sensors to communicate via IO-Link.

The DuraBeam laser sensors are durable and can be used in the same way as a standard sensor.

The use of Multi Pixel Technology gives the standard sensors a high level of flexibility and enables them to adapt more effectively to their operating environment.

Dimensions

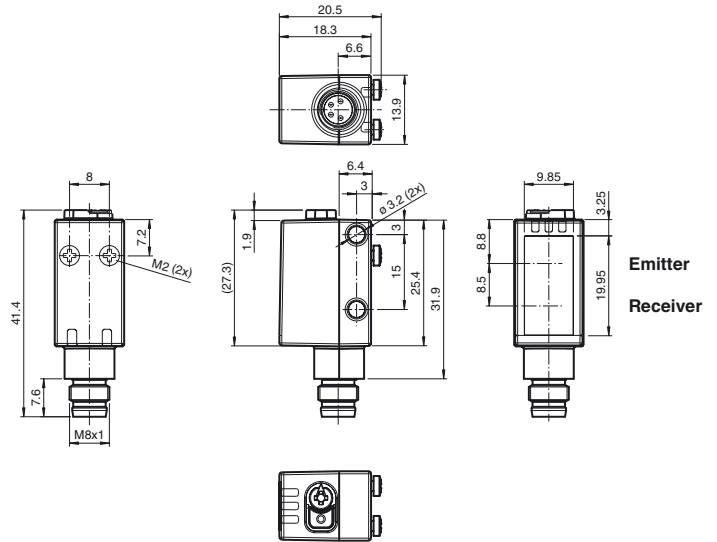

Electrical connection

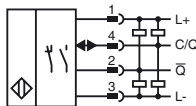

Pinout

Wire colors in accordance with EN 60947-5-2



- | | | |
|---|----|---------|
| 1 | BN | (brown) |
| 2 | WH | (white) |
| 3 | BU | (blue) |
| 4 | BK | (black) |

Indicators/operating means

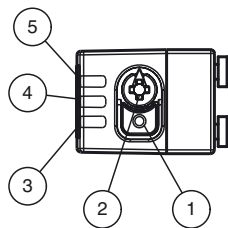

| | |
|---|------------------------------------|
| 1 | Light-on/dark-on changeover switch |
| 2 | Sensitivity adjuster |
| 3 | Operating indicator / dark on |
| 4 | Signal indicator |
| 5 | Operating indicator / light on |

Release date: 2018-06-08 14:17 Date of issue: 2018-06-08 267075-0128_eng.xml

Technical data**General specifications**

| | |
|----------------------------|----------------------------------------|
| Detection range | 2 ... 1000 mm |
| Detection range min. | 20 ... 50 mm |
| Detection range max. | 5 ... 1000 mm |
| Adjustment range | 75 ... 1000 mm |
| Reference target | standard white, 100 mm x 100 mm |
| Light source | LED |
| Light type | modulated visible red light |
| LED risk group labelling | exempt group |
| Diameter of the light spot | approx. 65 mm at a distance of 1000 mm |
| Angle of divergence | 3.7 ° |
| Ambient light limit | EN 60947-5-2 |

Functional safety related parameters

| | |
|--------------------------------|-------|
| MTTF _d | 724 a |
| Mission Time (T _M) | 20 a |
| Diagnostic Coverage (DC) | 0 % |

Indicators/operating means

| | |
|---------------------|-----------------------------------------------------------------------------------------------------------------------------|
| Operation indicator | LED green: constantly on - power on flashing (4Hz) - short circuit flashing with short break (1 Hz) - IO-Link mode |
| Function indicator | LED yellow: constantly on - object detected constantly off - object not detected |
| Control elements | Light-on/dark-on changeover switch |
| Control elements | Sensing range adjuster |

Electrical specifications

| | | |
|------------------------|----------------|--------------------------------|
| Operating voltage | U _B | 10 ... 30 V DC |
| Ripple | | max. 10 % |
| No-load supply current | I ₀ | < 25 mA at 24 V supply voltage |
| Protection class | | III |

Interface

| | |
|-----------------------------|-------------------------------------------------------|
| Interface type | IO-Link (via C/Q = pin 4) |
| Transfer rate | COM 2 (38.4 kBaud) |
| IO-Link Revision | 1.1 |
| Min. cycle time | 2.3 ms |
| Process data width | Process data input 1 Bit Process data output 2 Bit |
| SIO mode support | yes |
| Device ID | 0x110101 (1114369) |
| Compatible master port type | A |

Output

| | | |
|---------------------|---------------------------------------------------------------------------------------------------------------------------------------------------------------------------------------------------------------------------------------|------------|
| Switching type | The switching type of the sensor is adjustable. The default setting is: C/Q - Pin4: NPN normally open / light-on, PNP normally closed / dark-on, IO-Link /Q - Pin2: NPN normally closed / dark-on, PNP normally open / light-on | |
| Signal output | 2 push-pull (4 in 1) outputs, short-circuit protected, reverse polarity protected, overvoltage protected | |
| Switching voltage | max. 30 V DC | |
| Switching current | max. 100 mA , resistive load | |
| Usage category | DC-12 and DC-13 | |
| Voltage drop | U _d | ≤ 1.5 V DC |
| Switching frequency | f | 1000 Hz |
| Response time | | 0.5 ms |

Conformity

| | |
|-------------------------|--------------|
| Communication interface | IEC 61131-9 |
| Product standard | EN 60947-5-2 |

Ambient conditions

| | |
|---------------------|--------------------------------|
| Ambient temperature | -40 ... 60 °C (-40 ... 140 °F) |
| Storage temperature | -40 ... 70 °C (-40 ... 158 °F) |

Mechanical specifications

| | |
|----------------------|-------------------------|
| Housing width | 13.9 mm |
| Housing height | 41.4 mm |
| Housing depth | 18.3 mm |
| Degree of protection | IP67 / IP69 / IP69K |
| Connection | M8 x 1 connector, 4-pin |
| Material | |
| Housing | PC (Polycarbonate) |
| Optical face | PMMA |
| Mass | approx. 10 g |

Approvals and certificates

| | |
|-------------|--------------------------------------------------------------|
| UL approval | E87056 , cULus Listed , class 2 power supply , type rating 1 |
|-------------|--------------------------------------------------------------|

Accessories**IO-Link-Master02-USB**

IO-Link master, supply via USB port or separate power supply, LED indicators, M12 plug for sensor connection

OMH-R101

Mounting Clamp

OMH-R101-Front

Mounting Clamp

OMH-4.1

Mounting Clamp

OMH-ML6

Mounting bracket

OMH-ML6-U

Mounting bracket

OMH-ML6-Z

Mounting bracket

V31-GM-2M-PUR

Female cordset, M8, 4-pin, PUR cable

V31-WM-2M-PUR

Female cordset, M8, 4-pin, PUR cable

Other suitable accessories can be found at

Curves/Diagrams

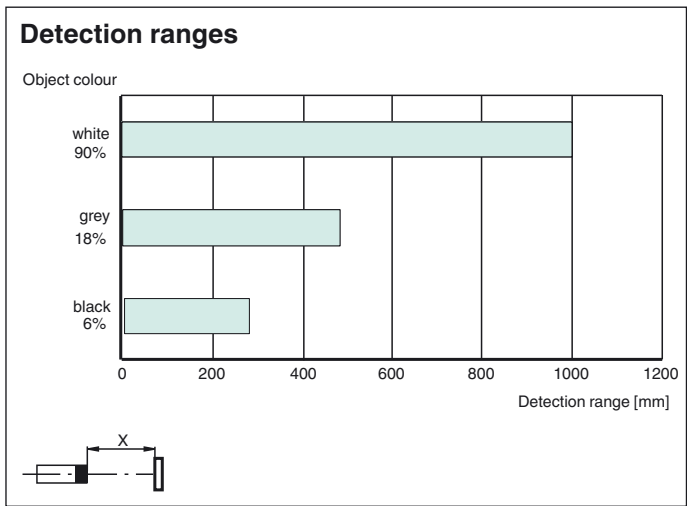
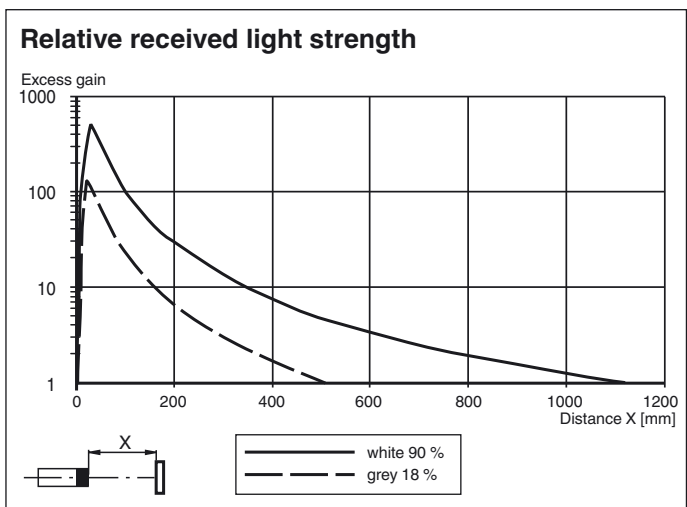
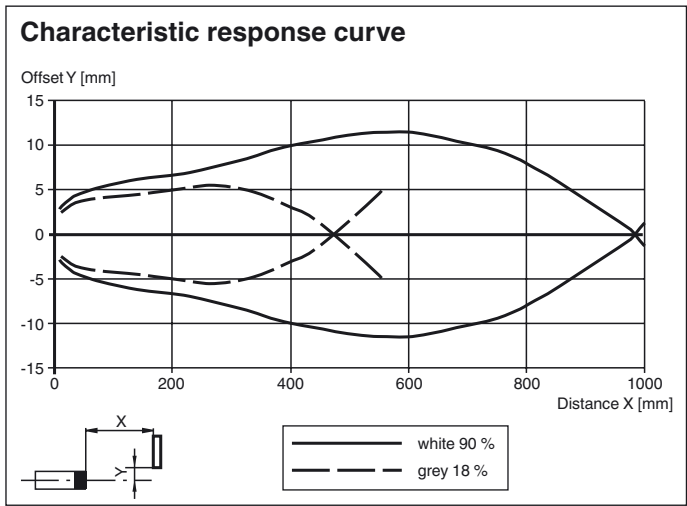

Release date: 2018-06-08 14:17 Date of issue: 2018-06-08 267075-0128_eng.xml

Functions and Operation

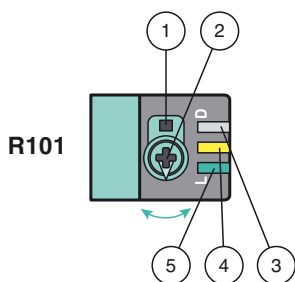

- 1 - Light-on / dark-on changeover switch
- 2 - Sensing range /sensitivity adjuster
- 3 - Operating indicator / dark on
- 4 - Signal indicator
- 5 - Operating indicator / light on

To unlock the adjustment functions turn the sensing range adjuster for more than 180 degrees.

Sensing Range / Sensitivity

Turn sensing range / sensitivity adjuster clockwise to increase sensing range / sensitivity.

Turn sensing range /sensitivity adjuster counter clockwise to decrease sensing range / sensitivity.

If the end of the adjustment range is reached, the signal indicator starts flashing with 8 Hz.

Light-on / Dark-on Configuration

Press the light-on / dark-on changeover switch for more than 1 second (less than 4 seconds). The light-on / dark-on mode changes and the operating indicators are activated accordingly.

If you press the light-on / dark-on changeover switch for more than 4 seconds, the light-on / dark-on mode changes back to the original setting. On release of the light-on / dark-on changeover switch the current state is activated.

Restore Factory Settings

Press the light-on / dark-on changeover switch for more than 10 seconds (less than 30 seconds) until all LEDs turn off. On release of the light-on / dark-on changeover switch the signal indicator turns on. After 5 seconds the sensor resumes operation with factory default settings.

After 5 minutes of inactivity the sensing range / sensitivity adjustment is locked. In order to reactivate the sensing range /sensitivity adjustment, turn the sensing range / sensitivity adjuster for more than 180 degrees.